



Blue Valley Cabinets

Where High Quality Cabinets Cost Less





Blue Valley Cabinets

Where High Quality Cabinets Cost Less



Schattdecor

The world-leading surface materials manufacturer based in Germany who operates sixteen production facilities worldwide, known for exceptional quality and design.

about us :

Blue Valley Cabinets Canada is new to the Lower Mainland of Vancouver area. Blue Valley Cabinets is adding to the quality and affordable products that are available in the region. We take pride in both our cabinets and customer service. Because our customers are so important to us, we strive to provide the best quality product at an affordable price.

Our designers are ready to assist you to create the kitchen you've always wanted but didn't think you could afford. With seven available styles and colors, we're sure you or your customers will find what you're looking for. Our (5) five years limited warranty will give you and your customers peace of mind knowing that we stand behind our products.

With six sister companies across the US & Canada, our manufacturer knows what it takes to produce quality cabinets at an affordable price. They take care in the cabinet manufacturing business for several years; they are able to manufacture cabinets that work with the different climates in which they are sold and installed.

Whether you want your cabinets assembled by us or you intend to do it yourself, we stand ready to provide you with the best possible service. Pickup and delivery options are available. All the woodgrain flat panels materials we used in our European-style cabinets and walk-in closets line are from Schattdecor, for ensuring both elegance and durability in every detail.

Exploded View & Component List



#	Description	Materials
1	3/4" Thick Back Enforced Rail	PW
2	Ø7×50mm Screw	-
3	Ø8×30mm Wooden Dowel	-
4	1/4" Thick MDF Back Panel	MDF
5	3/4" Thick Adjustable Shelf	PW
6	Stainless Steel Shelf Clamp	Steel
7	3/4" Thick Left Side Panel	PW
8	3/4" Thick Bottom Panel	PW
9	3/4" Thick Front Enforced Toe Kick	PW
10	3/4" Thick Top-Back Enforced Rail	PW
11	3/4" Thick Right-Side Panel	PW
12	Back Panel of Drawer Box	PB
13	Double Wall Soft Closing Metal Drawer	-
14	Bottom Panel of Drawer Box	PB
15	3/4" Thick Middle Enforced Rail	PW
16	3/4" Thick Top-Front Enforced Rail	PW
17	6-ways Adjustable, Soft-Close Hinges	Metal
18	3/4" Thick Drawer Panel	PB/MDF/HW
19	3/4" Thick Full Overlay Door Panel	PB/MDF/HW

*PW: Plywood *HW: Hardwood *PB: Particleboard

TABLE OF CONTENTS

Base Cabinet	Page	5
Wall Cabinet	Page	9
Pantry	Page	14
Vanity	Page	17
Glass Door Cabinets	Page	23
Cabinet Accessories	Page	23
Floating Shelves	Page	23
Closets	Page	24





**BLUE VALLEY
CABINETS**

Base Cabinet	ITEM	W	D	H
	B09	09"	24"	34 ¹ / ₂ "
	B12	12"	24"	34 ¹ / ₂ "
	B15	15"	24"	34 ¹ / ₂ "
	B18	18"	24"	34 ¹ / ₂ "
One Door + One Drawer				
6" Height drawer and 24" height door				

Base Full Door Cabinet	ITEM	W	D	H
	B09FHD	09"	24"	34 ¹ / ₂ "
	B12FHD	12"	24"	34 ¹ / ₂ "
	B15FHD	15"	24"	34 ¹ / ₂ "
	B18FHD	18"	24"	34 ¹ / ₂ "
Double doors style				
Full height one door style.				

3-Drawers Base Cabinet	ITEM	W	D	H
	B24	24"	24"	34 ¹ / ₂ "
	B27	27"	24"	34 ¹ / ₂ "
	B30	30"	24"	34 ¹ / ₂ "
	B33	33"	24"	34 ¹ / ₂ "
	B36	36"	24"	34 ¹ / ₂ "
Double Doors + One Drawer				
6" height drawer and 24" height doors				

Base Full Door Cabinet	ITEM	W	D	H
	B24FHD	24"	24"	34 ¹ / ₂ "
	B27FHD	27"	24"	34 ¹ / ₂ "
	B30FHD	30"	24"	34 ¹ / ₂ "
	B33FHD	33"	24"	34 ¹ / ₂ "
	B36FHD	36"	24"	34 ¹ / ₂ "
Double Full Height Doors				
Full height double doors style				

2-Drawers Base Cabinet		ITEM	W	D	H
	DB12-2	12"	24"	34 ¹ / ₂ "	
	DB15-2	15"	24"	34 ¹ / ₂ "	
	DB18-2	18"	24"	34 ¹ / ₂ "	
	DB21-2	21"	24"	34 ¹ / ₂ "	
	DB24-2	24"	24"	34 ¹ / ₂ "	
	DB27-2	27"	24"	34 ¹ / ₂ "	
	DB30-2	30"	24"	34 ¹ / ₂ "	
	DB33-2	33"	24"	34 ¹ / ₂ "	
	DB36-2	36"	24"	34 ¹ / ₂ "	
Two equal height drawers' style (15")					

Sink Base Cabinet		ITEM	W	D	H
	SB30	30"	24"	34 ¹ / ₂ "	
	SB33	33"	24"	34 ¹ / ₂ "	
	SB36	36"	24"	34 ¹ / ₂ "	
	SB39	36"	24"	34 ¹ / ₂ "	
	Double doors style				
6" height dummy drawer panel on top					

3-Drawers Base Cabinet		ITEM	W	D	H
	DB12-3	12"	24"	34 ¹ / ₂ "	
	DB12-3	15"	24"	34 ¹ / ₂ "	
	DB12-3	18"	24"	34 ¹ / ₂ "	
	DB12-3	21"	24"	34 ¹ / ₂ "	
	DB12-3	24"	24"	34 ¹ / ₂ "	
	DB12-3	27"	24"	34 ¹ / ₂ "	
	DB12-3	30"	24"	34 ¹ / ₂ "	
	DB12-3	33"	24"	34 ¹ / ₂ "	
	DB12-3	36"	24"	34 ¹ / ₂ "	
12" height dummy drawer panel					

Base Cabinet		ITEM	W	D	H
	FSM33	33"	24"	34 ¹ / ₂ "	
	FSM36	36"	24"	34 ¹ / ₂ "	
Double doors style					
12" height dummy drawer panel					



Sink Base Full Door Cabinet	ITEM	W	D	H
	SB30FHD	30"	24"	34½"
	SB33FHD	33"	24"	34½"
	SB36FHD	36"	24"	34½"
	SB39FHD	39"	24"	34½"
Full height double doors style				

Base Cabinet	ITEM	W	D	H
	BBC30FHD-12	09"	24"	34½"
	BBC36FHD-15	12"	24"	34½"
	BBC42FHD-18	15"	24"	34½"

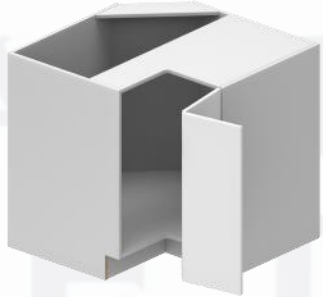
Base Microwave Cabinet	ITEM	W	D	H
	BMC27	27"	24"	34½"
	BMC30	30"	24"	34½"
Appliance space height=16"				
12" height drawer on the bottom				

Base Microwave Cabinet	ITEM	W	D	H
	BkS33	33"	33"	34½"
	BkS36	36"	36"	34½"
Optional BLS36-Tray Sold Separatly				
Lazy Susan hardware is include				
Hinge open angle is 155°(box-door)and 270°(door-door)				

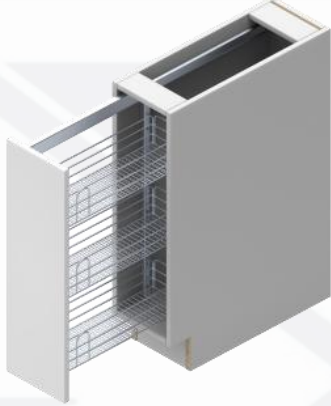
Corner Sink Base Cabinet	ITEM	W	D	H
	CSB36	36"	36"	34¹/₂"
	<p>Full height one door style</p>			

Base Spice Rack Cabinet	ITEM	W	D	H
	SP09	09"	24"	34¹/₂"
	SP12	12"	24"	34¹/₂"
				
<p>hardware is included</p>				

Corner Sink Base Cabinet	ITEM	W	D	H
	CSB42	42"	42"	34¹/₂"
	<p>ACCESSORIES Find stylish accessories like floating shelves and roll-out trays on page 20 perfect for adding extra function and flair to your space</p>			

Corner Sink Base Cabinet	ITEM	W	D	H
	BWBK18	18"	24"	34¹/₂"
				
<p>2 Trash cans</p>				





Wall Cabinets





Wall Cabinet-30"H	ITEM	W	D	H
	W0930	09"	12"	30"
	W1230	12"	12"	30"
	W1530	15"	12"	30"
	W1830	18"	12"	30"
	W2130	21"	12"	30"
One door style				

Wall Cabinet-30"H	ITEM	W	D	H
	W0936	09"	12"	36"
	W1236	12"	12"	36"
	W1536	15"	12"	36"
	W1836	18"	12"	36"
	W2136	21"	12"	36"
36" height cabinets have 2 adjustable shelves				

Wall Cabinet-30"H	ITEM	W	D	H
	W2430	24"	12"	30"
	W2730	27"	12"	30"
	W3030	30"	12"	30"
	W3330	33"	12"	30"
	W3630	36"	12"	30"
30" height cabinets have 2 adjustable shelves				

Wall Cabinet-36"H	ITEM	W	D	H
	W2436	24"	12"	36"
	W2736	27"	12"	36"
	W3036	30"	12"	36"
	W3336	33"	12"	36"
	W3636	36"	12"	36"
Double Doors				
36" height cabinets have 2 adjustable shelves				

Wall Cabinet-42"H	ITEM	W	D	H
	W0942	09"	12"	42"
	W1242	12"	12"	42"
	W1542	15"	12"	42"
	W1842	18"	12"	42"
	W2142	21"	12"	42"
42" height cabinets have 3 adjustable shelves				

Wall Blind Corner Cabinet	ITEM	W	D	H
	WBC3030	30"	12"	30"
	WBC3036	30"	12"	36"
15" width doors and 6" width filler				
30" & 36" height cabinets have 2 shelves				

Wall Cabinet-42"H	ITEM	W	D	H
	W2442	24"	12"	42"
	W2742	27"	12"	42"
	W3042	30"	12"	42"
	W3342	33"	12"	42"
	W3642	36"	12"	42"
42" height cabinets have 3 adjustable shelves				

Wall Blind Corner Cabinet	ITEM	W	D	H
	WBC3042	30"	12"	42"
15" width doors and 6" 42" have 3 shelves				

Wall Diagonal Cabinet	ITEM	W	D	H
	WDC2430	24"	24"	30"
	WDC2436	24"	24"	36"
	WDC2442	24"	24"	42"
<p>30" & 36" height cabinets have 2 shelves Hinge open angle=45°</p>				

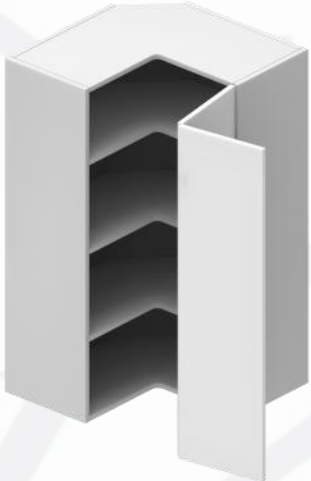
Base Cabinet	ITEM	W	D	H
	Wks2442	24"	24"	42"
	<p>Two attached doors</p>			
<p>42" have 3 shelves Hinge open angle is 155° and 270°(door-door)</p>				

Wall Cabinet-42"H	ITEM	W	D	H
	WDC2442	24"	24"	42"
	<p>42" have 3 shelves</p>			
<p>Hinge open angle=45°</p>				

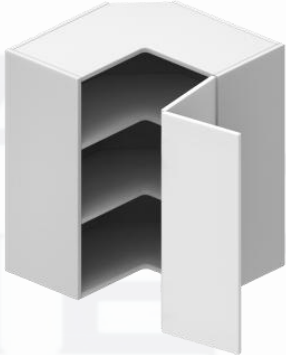
Wall Easy Reach Cabinet	ITEM	W	D	H
	Wks2430	24"	24"	30"
	Wks2436	24"	24"	30"
<p>Two attached doors</p>				
<p>30" & 36" height cabinets have 2 shelves</p>				
<p>Hinge open angle is 155°(box-door)and 270°(door-door)</p>				

Wall Cabinet - 12" H	ITEM	W	D	H
	W3012	30"	12"	12"
	W3015	30"	12"	15"
	W3018	30"	12"	18"
	W3021	30"	12"	21"
	W3612	36"	12"	12"
	W3615	36"	12"	15"
	W3618	36"	12"	18"
	W3621	36"	12"	21"
	W3012	30"	12"	12"
Double door style				

Wall Cabinet - 24" D	ITEM	W	D	H
	W301224	30"	24"	12"
	W301524	30"	24"	15"
	W301824	30"	24"	18"
	W302124	30"	24"	21"
	W361224	36"	24"	12"
	W361524	36"	24"	15"
	W361824	36"	24"	18"
	W362124	36"	24"	21"
Double door style				

Wall Cabinet - 24" H	ITEM	W	D	H
	W3024	30"	12"	24"
	W3624	36"	12"	24"

Wall Cabinet - 24" H	ITEM	W	D	H
	W3024	30"	12"	24"
	W3624	36"	12"	24"



Wall Single Lift Cabinet	ITEM	W	D	H
	WSL3012	30"	12"	12"
	WSL3015	30"	12"	15"
	WSL3018	30"	12"	18"
	WSL3612	36"	12"	12"
	WSL3615	36"	12"	15"
	WSL3618	36"	12"	18"
One Door , Lift up Style				



Wall Single Lift Cabinet	ITEM	W	D	H
	WBF3030	30"	12"	30"
	WBF3036	30"	12"	36"
	WBF3630	36"	12"	30"
	WBF3636	36"	12"	36"
Fold up style, two attached doors divided equally				

Pantry





**BLUE VALLEY
CABINETS**

Pantry Cabinet	ITEM	W	D	H
	PC1896	18"	24"	96"
	<p data-bbox="712 730 967 762">Double doors style</p> 			
<p data-bbox="331 1353 869 1385">Option for upgrade, adding accessories</p>				

Pantry Cabinet	ITEM	W	D	H
	PC1884	18"	24"	84"
	PC1890	18"	24"	90"
<p data-bbox="1753 762 2009 794">Double doors style</p> 				
<p data-bbox="1361 1353 1921 1385">roll out trays sold separately see page 25</p>				

Pantry Cabinet	ITEM	W	D	H
	PC2484	24"	24"	84"
	PC3084	30"	24"	84"
	PC3684	36"	24"	84"
	PC2490	24"	24"	90"
	PC3090	30"	24"	90"
	PC3690	36"	24"	90"
Four doors style				

Microwave Tall Cabinet	ITEM	W	D	H
	W0936	09"	12"	36"
	W1236	12"	12"	36"
	W1536	15"	12"	36"
Double Doors , double drawers + double filler				

Pantry Cabinet	ITEM	W	D	H
	PC2496	24"	24"	96"
	PC3096	30"	24"	96"
	PC3696	36"	24"	96"
				
Four doors style				

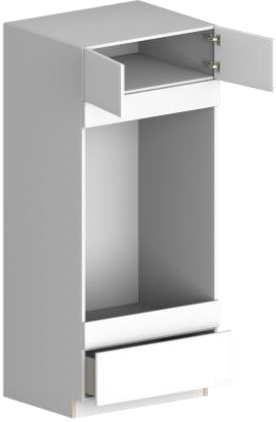
Double-Oven Tall Cabinet	ITEM	W	D	H
	DOC3084	30"	24"	84"
	DOC3090	30"	24"	90"
	DOC3096	30"	24"	96"
Double doors + one drawer + double fillers				

Vanity



Vanity Full Door Sink Cabinet	ITEM	W	D	H
	FVB24	24"	21"	24"
	FVB27	27"	21"	24"
	FVB30	30"	21"	24"
	FVB33	33"	21"	24"
	FVB36	36"	21"	24"
Full height double doors style				
Alternative by corresponding kitchen cabinet doors				

Floating Vanity Sink Cabinet	ITEM	W	D	H
	FVSD24	24"	21"	24"
	FVSD30	30"	21"	24"
	FVSD36	36"	21"	24"
6",12" & 12" height drawers segmented from top [Two U-shaped accessories]				
Alternative by corresponding kitchen cabinet doors				

Vanity Base Full Door Cabinet	ITEM	W	D	H
	FVDB12	12"	21"	24"
	FVDB15	15"	21"	24"
	FVDB18	18"	21"	24"
	FVDB21	21"	21"	24"
	FVDB24	24"	21"	24"
	FVDB27	27"	21"	24"
	FVDB30	30"	21"	24"
	FVDB33	33"	21"	24"
	FVDB36	36"	21"	24"
Two Equal height drawer				

Glass Door	ITEM	W	D	H
	GD1230	12"	12"	30"
	GD1530	15"	12"	30"
	GD1830	18"	12"	30"
	GD-WDC2430	24"	12"	30"
	GD1236	12"	12"	30"
	GD1536	15"	12"	30"
	GD1836	18"	12"	30"
	GD-WDC2436	24"	12"	30"
	GD1242	12"	12"	30"
	GD1542	15"	12"	30"
	GD1842	18"	12"	30"
	GD-WDC2442	24"	12"	30"

Vanity Full Height Door Match End Panel	ITEM	W	D	H
	VFD22	21' / 8"	/ 4"	34 1/2"
	Use for Bath unit			
Same material as door panel, 3/4" thickness				

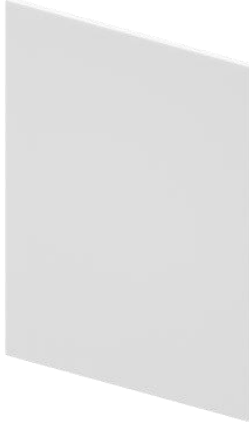
Base Full Height Door Match End Panel	ITEM	W	D	H
	BFD25	24' / 8"	/ 4"	34 1/2"
	Use for Kitchen base unit			
Same material as door panel, 3/4" thickness				

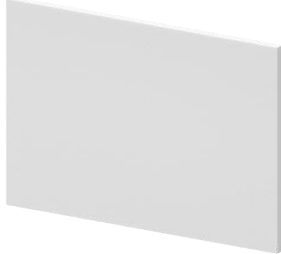
Vanity Full Height Door Match End Panel	ITEM	W	D	H
	FVFD22	21' / 8"	/ 4"	24"
	Use for Floating Vanity			

Double-Oven Tall Cabinet	ITEM	W	D	H
	FD1330	12' / 8"	/ 4"	30"
	FD1336	12' / 8"	/ 4"	36"
	FD1342	12' / 8"	/ 4"	42"
	Use for Kitchen wall unit			

Refrigerator End Panel	ITEM	W	D	H
	REP8425	24' / 8"	/ 4"	84"
	REP9025	24' / 8"	/ 4"	90"
	REP9625	24' / 8"	/ 4"	96"
	Use for Refrigerator position			

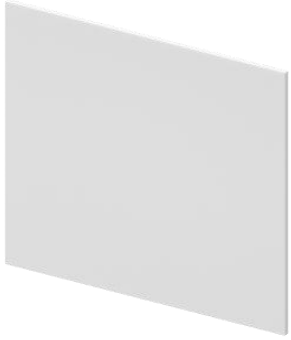
Base Skin Panel	ITEM	W	D	H
	BFD25	24' / 8"	/ 4"	34' / 2"
	Use for Kitchen Same material as door panel, 3/4" thickness			

Base Skin Panel	ITEM	W	D	H
	PNL34.5*96*3/4	34' / 2"	/ 4"	96"
	<ul style="list-style-type: none"> - Use for Island or Peninsula in Kitchen - Same material as door panel 3/4" thickness 			

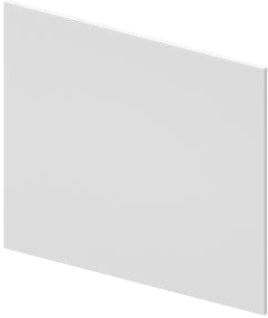

Base Skin Panel Island	ITEM	W	D	H
	PNL34.5*36*3/4	34' / 2"	/ 4"	96"
	<ul style="list-style-type: none"> - Use for Kitchen - Same material as door panel 3/4" thickness - For example, 24" deep + 12" deep cabinets back to back 			

Tall Filler	ITEM	W	D	H
	TF3*96	3"	1/4"	96"
	TF6*96	6"	1/4"	96"
	Same material as door panel, 3/4" thickness			

Wall Filler	ITEM	W	D	H
	WF330	3"	1/4"	29'8"
	WF336	3"	1/4"	35'8"
	WF342	3"	1/4"	41'8"
	WF630	6"	1/4"	29'8"
	WF636	6"	1/4"	35'8"
	WF642	6"	1/4"	41'8"
Same material as door panel, 3/4" thickness				

TOE KICK	ITEM	W	D	H
	TK8			
	Same material as door panel, 3/4" thickness			

Base Skin Panel	ITEM	W	D	H
	DWR	3"	24"	34 1/2"
	Use for Dishwasher position - Door panel material Left & Right Reversible			

Roll Out Trays	ITEM	W	D	H
	ROT18	14.3"	19.78"	4.65"
	ROT24	20.3"	19.78"	4.65"
	ROT30	26.3"	19.78"	4.65"
	ROT36	32.3"	19.78"	4.65"
				

Base Blind Corner Tray				
	ITEM	W	D	H
	BBC-Tray-L			
	BBC-Tray-R			

HANDLELESS Bottom Panel				
	ITEM	W	D	H
	W12	10.59	11.18"	.71"
	W15	13.58"	11.18"	.71"
	W18	16.59"	11.18"	.71"
	W24	22.59"	11.18"	.71"
	W30	28.59"	11.18"	.71"
	W36	34.59"	11.18"	.71"
	WDC	22.60"	11.18"	.71"

FLOATING SHELVES				
	ITEM	W	D	H
	FS30	30"	12.08"	1.46"
	FS36	36"	12.08"	1.46"

Base Lazy Suzan Tray				
	ITEM	W	D	H
	BLS-36-Tray	36"		Adj
				



Blue Valley Cabinets

Where High Quality Cabinets Cost Less



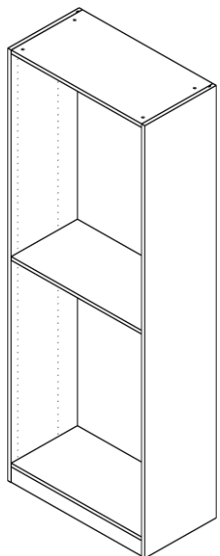

ITEM	W	D	H
C1584F	15"	15 ⁵ / ₈ "	84"
C1884F	18"	15 ⁵ / ₈ "	84"
C2184F	21"	15 ⁵ / ₈ "	84"
C2484F	24"	15 ⁵ / ₈ "	84"
C3084F	30"	15 ⁵ / ₈ "	84"
C3684F	36"	15 ⁵ / ₈ "	84"

Description:

*Include 1 adjustable shelf.
 *Clothes hanging rails, movable shelves, and drawers can be added.
 *30" and 36" width closet can be equipped with functional hardware.

Package:

CTN 1:Left & right side panel
 CTN 2:Top & bottom panel*1 + shelf*1 + enforced rail*3 + TK*1
 + basic hardware*1
 CTN 3:Back panel*1

ITEM	W	D	H
ER3084F	30"	15"	84"
ER3684F	36"	15"	84"

Description:

*Include 1 adjustable shelf.
 *Clothes hanging rails, movable shelves, and drawers can be added.

Package:

CTN 1:Left & right side panel*1
 CTN 2:Top & bottom panel*1 + shelf*1 + TK*2 + basic hardware*1
 CTN 3:Back panel*2 (Back Panel thickness 3/4")

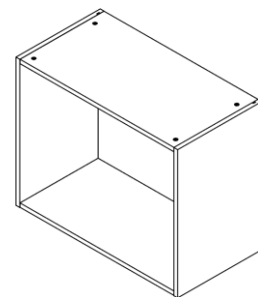
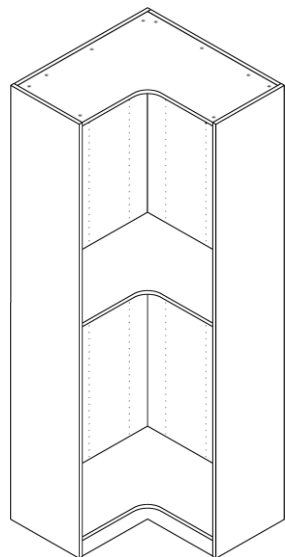

ITEM	W	D	H
C1521	15"	15 ⁵ / ₈ "	21"
C1821	18"	15 ⁵ / ₈ "	21"
C2121	21"	15 ⁵ / ₈ "	21"
C2421	24"	15 ⁵ / ₈ "	21"
C3021	30"	15 ⁵ / ₈ "	21"
C3621	36"	15 ⁵ / ₈ "	21"

Description:

*Place it on top of a closet with the same width ,Use Filler to fill the remaining space,to fit a 9' floor height.

Package:

1 Set/CTN

ITEM	W	D	H
ER3021	30"	15"	21"
ER3621	36"	15"	21"

Description:

*Place it on top of a closet with the same width ,Use Filler to fill the remaining space,to fit a 9' floor height.

Package:

1 Set/CTN

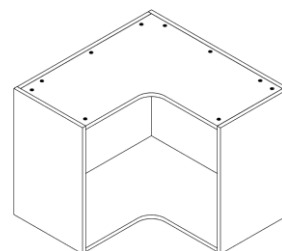

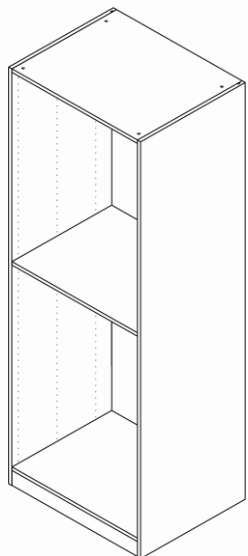

ITEM	W	D	H
C1584DF	15"	24"	84"
C1884DF	18"	24"	84"
C2184DF	21"	24"	84"
C2484DF	24"	24"	84"
C3084DF	30"	24"	84"
C3684DF	36"	24"	84"

Description:

*Include 1 adjustable shelf.
 *Clothes hanging rails, movable shelves, and drawers can be added.
 *30" and 36" width closet can be equipped with functional hardware.

Package:

CTN 1: Left & right side panel.
 CTN 2: Top & bottom panel*1 + shelf panel*1 + enforced rail*3 + TK*1
 + basic hardware*1
 CTN 3: Back panel*1

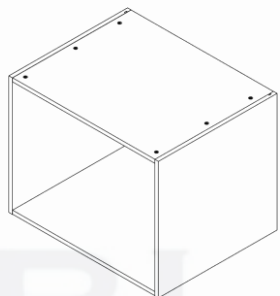

ITEM	W	D	H
C1521	15"	15 $\frac{5}{8}$ "	21"
C1821	18"	15 $\frac{5}{8}$ "	21"
C2121	21"	15 $\frac{5}{8}$ "	21"
C2421	24"	15 $\frac{5}{8}$ "	21"
C3021	30"	15 $\frac{5}{8}$ "	21"
C3621	36"	15 $\frac{5}{8}$ "	21"

Description:

*Place it on top of a closet with the same width
 Use Filler to fill the remaining space, to fit a 9' floor height.

Package:

1 Set/CTN

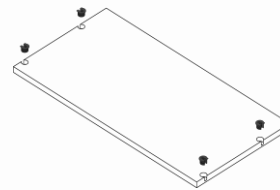

ITEM	W	D	H
S15	15"	3/4"	14 $\frac{1}{2}$ "
S18	18"	3/4"	14 $\frac{1}{2}$ "
S21	21"	3/4"	14 $\frac{1}{2}$ "
S24	24"	3/4"	14 $\frac{1}{2}$ "
S30	30"	3/4"	14 $\frac{1}{2}$ "
S36	36"	3/4"	14 $\frac{1}{2}$ "

Description:

*Exchangeable shelf fit for 15" depth units
 *Code number refers to fit width

Package:

3 Set/CTN (S15/S18)
 1PC/CTN (S21-S36)

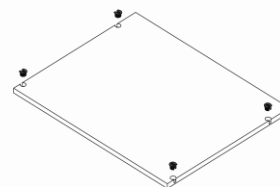

ITEM	W	D	H
S15D	15"	3/4"	22 $\frac{5}{8}$ "
S18D	18"	3/4"	22 $\frac{5}{8}$ "
S21D	21"	3/4"	22 $\frac{5}{8}$ "
S24D	24"	3/4"	22 $\frac{5}{8}$ "
S30D	30"	3/4"	22 $\frac{5}{8}$ "
S36D	36"	3/4"	22 $\frac{5}{8}$ "

Description:

*Exchangeable shelf fit for 24" depth units
 *Code number refers to fit width

Package:

3 Set/CTN (S15D/S18D)
 1PC/CTN (S21D-S36D)

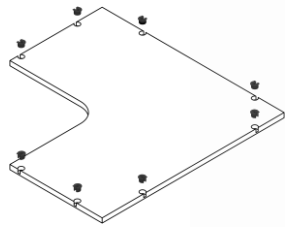

ITEM	W	D	H
S30ER	30"	¾"	15"
S36ER	36"	¾"	15"

Description:

*Exchangeable shelf fit for corner units
 *Code number refers to fit width

Package:

1 Set/CTN

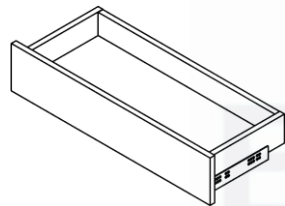

ITEM	W	D	H
DK15N	15"	12"	6 ⁵ / ₁₆ "
DK18N	18"	12"	6 ⁵ / ₁₆ "
DK21N	21"	12"	6 ⁵ / ₁₆ "
DK24N	24"	12"	6 ⁵ / ₁₆ "
DK30N	30"	12"	6 ⁵ / ₁₆ "
DK36N	36"	12"	6 ⁵ / ₁₆ "

Description:

*160mm (6⁵/₁₆") front hight drawer.
 *Include box and slide, suit for 15%" depth section unit.

Package:

1 Set/CTN

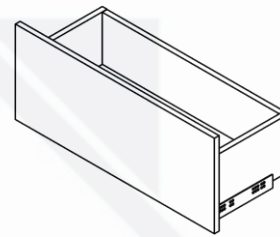

ITEM	W	D	H
DK15H	15"	12"	12 ⁵ / ₈ "
DK18H	18"	12"	12 ⁵ / ₈ "
DK21H	21"	12"	12 ⁵ / ₈ "
DK24H	24"	12"	12 ⁵ / ₈ "
DK30H	30"	12"	12 ⁵ / ₈ "
DK36H	36"	12"	12 ⁵ / ₈ "

Description:

*320mm (12⁵/₈") front hight drawer,
 *Include box and slide, suit for 15%" depth section unit.

Package:

1 Set/CTN

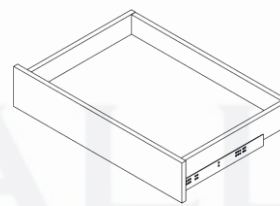

ITEM	W	D	H
DK15DN	15"	20"	6 ⁵ / ₁₆ "
DK18DN	18"	20"	6 ⁵ / ₁₆ "
DK21DN	21"	20"	6 ⁵ / ₁₆ "
DK24DN	24"	20"	6 ⁵ / ₁₆ "
DK30DN	30"	20"	6 ⁵ / ₁₆ "
DK36DN	36"	20"	6 ⁵ / ₁₆ "

Description:

*160mm (6⁵/₁₆") front hight drawer,
 *Include box and slide, suit for 24" depth section unit.

Package:

1 Set/CTN

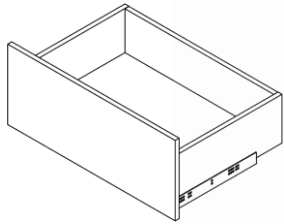

ITEM	W	D	H
DK15DH	15"	20"	12 ⁵ / ₈ "
DK18DH	18"	20"	12 ⁵ / ₈ "
DK21DH	21"	20"	12 ⁵ / ₈ "
DK24DH	24"	20"	12 ⁵ / ₈ "
DK30DH	30"	20"	12 ⁵ / ₈ "
DK36DH	36"	20"	12 ⁵ / ₈ "

Description:

*320mm (12⁵/₈") front hight drawer,
 *Include box and slide, suit for 24" depth section unit.

Package:

1 Set/CTN



ITEM	W	D	H
GD1281	12"	9 ¹ / ₁₆ "	81"
GD1581	15"	13 ¹ / ₁₆ "	81"
GD1881	18"	9 ¹ / ₁₆ "	81"
GD2181	21"	13 ¹ / ₁₆ "	81"

Description:

*Glass door, including hinges

Package:

1 Set/CTN



ITEM	W	D	H
Side Panel with LED Light	15 ⁵ / ₈ "	3 ¹ / ₄ "	84"

Description:

*Left & right side panel with LED lights.
 *Suit for 15⁵/₈" depth section unit.

Package:

Left & right side panel*1/CTN



ITEM	W	D	H
Side Panel with LED Light	24"	3 ¹ / ₄ "	84"

Description:

*Left & right side panel with LED lights.
 *Suit for 24" depth section unit.

Package:

Left & right side panel*1/CTN



ITEM	W	D	
TR30	30"	13 $\frac{5}{8}$ "	
TR36	36"	13 $\frac{5}{8}$ "	

Description:

- Fit for 30" and 36" width section units,
- Grey Pants Rack with soft close slide.
- Include box and slide, suit for 15 $\frac{5}{8}$ " depth section unit.

Package:

1 PC/CTN



ITEM	W	D	
OD30	30"	13 $\frac{5}{8}$ "	
OD36	36"	13 $\frac{5}{8}$ "	

Description:

- Fit for 30" and 36" width section units,
- Jewelry Rack – Velvet- Lined Divider Tray
- 12 Compartments

Package:

1 PC/CTN

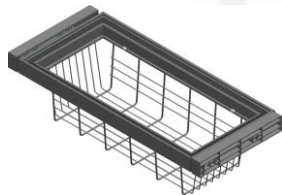

ITEM	W	D	
BSK30	30"	13 $\frac{5}{8}$ "	
BSK36	36"	13 $\frac{5}{8}$ "	

Description:

- Fit for 30" and 36" width section units,
- Gray Storage Basket for 15" Depth.
- Include box and slide, suit for 15 $\frac{5}{8}$ " depth section unit.

Package:

1 PC/CTN



ITEM	W	D	
TR30D	30"	19 $\frac{1}{8}$ "	
TR36D	36"	19 $\frac{1}{8}$ "	

Description:

- Fit for 30" and 36" width section units.
- Grey Pants Rack with soft close slide.
- Include box and slide, suit for 24" depth section unit.

Package:

1 PC/CTN



ITEM	W	D	
OD30D	30"	19 $\frac{1}{8}$ "	
OD36D	36"	19 $\frac{1}{8}$ "	

Description:

- Fit for 30" and 36" width section units,
- Jewelry Rack – Velvet- Lined Divider Tray

Package:

1 PC/CTN



ITEM	W	D	
BSK30D	30"	19 $\frac{1}{8}$ "	
BSK36D	36"	19 $\frac{1}{8}$ "	

Description:

- Fit for 30" and 36" width section units
- Gray Storage Basket for 24" Depth
- Include box and slide, suit for 24" depth section unit.

Package:

1 PC/CTN



ITEM	W	H	
MIR1437	14"	37"	

Description:

*Mirror with slide mount rack

Package:

1 PC/CTN



ITEM	W		
HR15	15"		
HR18	18"		
HR21	21"		
HR24	24"		
HR30	30"		
HR36	36"		

Description:

*Code number refers to fit width.

Package:

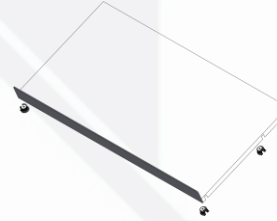

ITEM	W	D	H
SS24	24"	3/4"	14 1/2"
SS30	30"	3/4"	14 1/2"
SS36	36"	3/4"	14 1/2"

Description:

*Shoe shelf with front bar, tilt install in 15 1/2" depth sections

Package:

2 Sets/CTN

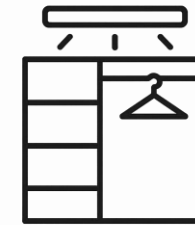

UPGRADE WITH LED LIGHTS

Enhance your closet design with the option to upgrade to LED lighting. This sleek, low-profile feature adds both function and ambiance. A smart upgrade for a polished, high-end finish.



Our modern closet line is built around a modular system designed for flexibility, simplicity, and style. Whether you're outfitting a primary suite or a compact reach-in, our components can be mixed, matched, and rearranged to fit your exact space and storage needs. Even better—our on-site designers use 3D-printed model pieces to help you visualize and configure your ideal setup in real time. It's a hands-on, hassle-free way to create a custom-feeling closet without the custom timeline or price.



Blue Valley Cabinets

Where High Quality Cabinets Cost Less



Modular Kitchen cabinets ,Vanity & Closet Catalogue 2026

Blue Valley Cabinet Canada Ltd.

6741 Cariboo Rd #117 , Burnaby BC CANADA V3N 4A3
Office : 604-420-0667 Email : info@bluevalleycabinets.ca

www.bluevalleycabinets.ca

Visit Our Website:

